













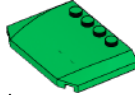















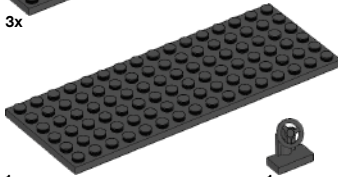









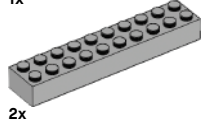



- 
1x
- 
1x
- 
1x
- 
1x
- 
1x
- 
1x
- 
4x
- 
3x
- 
2x
- 
2x
- 
3x
- 
5x
- 
1x
- 
1x
- 
1x
- 
2x
- 
1x
- 
1x
- 
1x
- 
1x
- 
4x
- 
3x
- 
1x
- 
1x
- 
12x
- 
6x
- 
5x
- 
3x
- 
12x
- 
1x
- 
2x
- 
2x
- 
1x
- 
2x
- 
1x
- 
4x
- 
2x
- 
4x
- 
4x
- 
12x
- 
8x
- 
10x
- 
4x
- 
2x
- 
4x
- 
2x



1

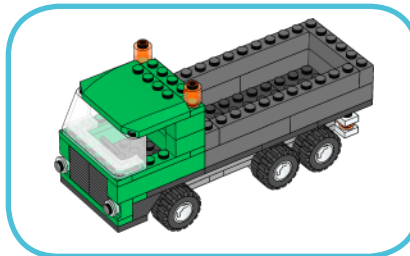
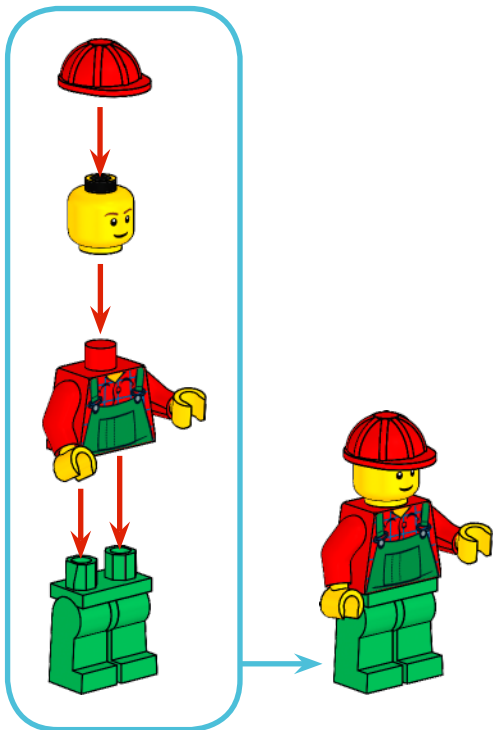
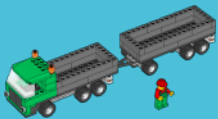
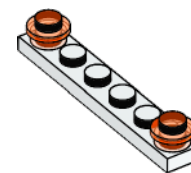

2



3

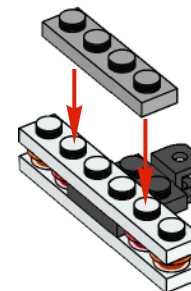

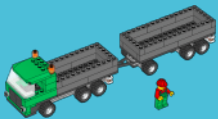

4

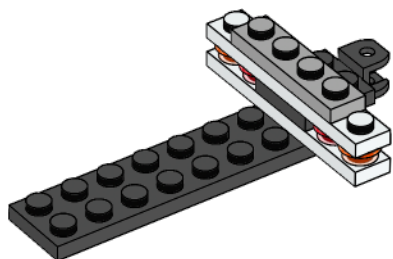

5

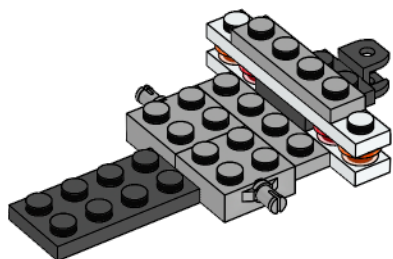

6

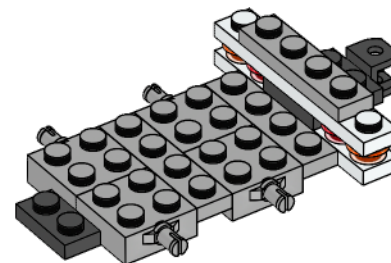

7

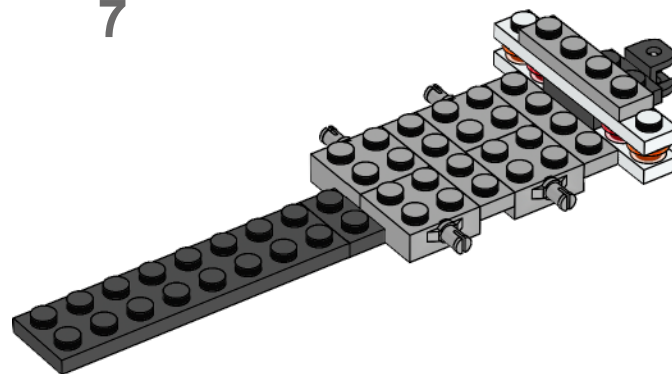

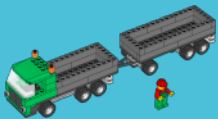

8

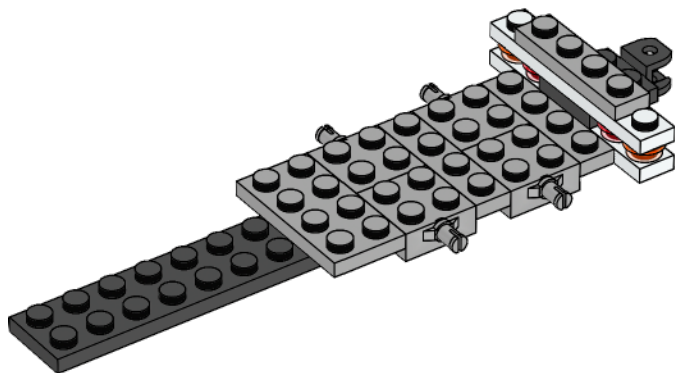

9

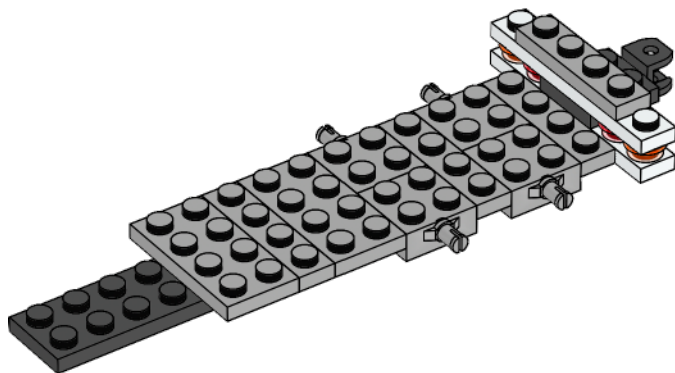

10

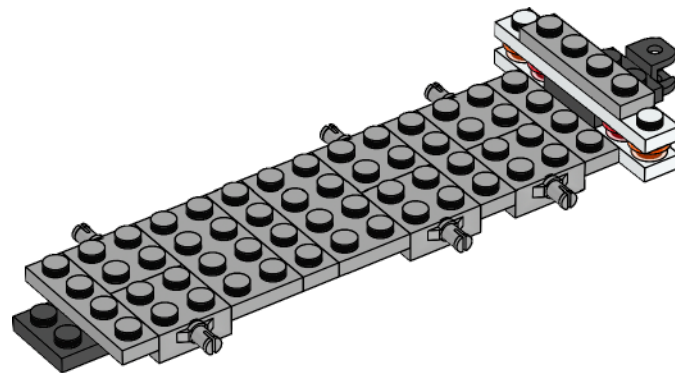

11

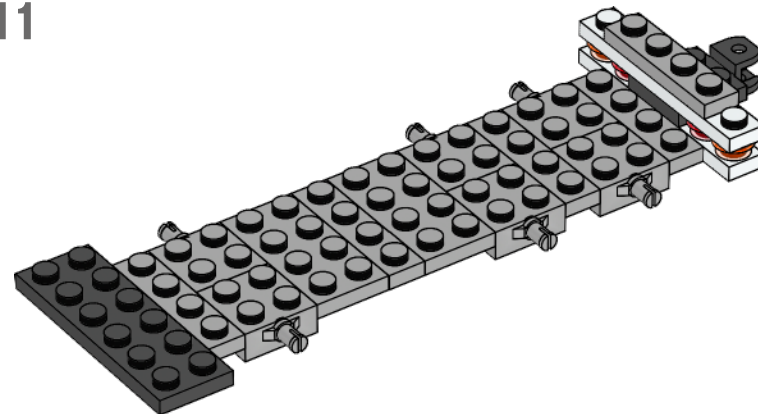

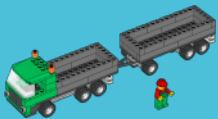

12

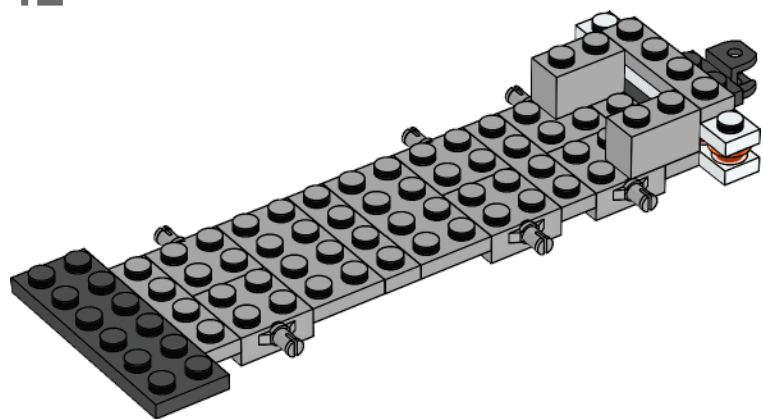

13

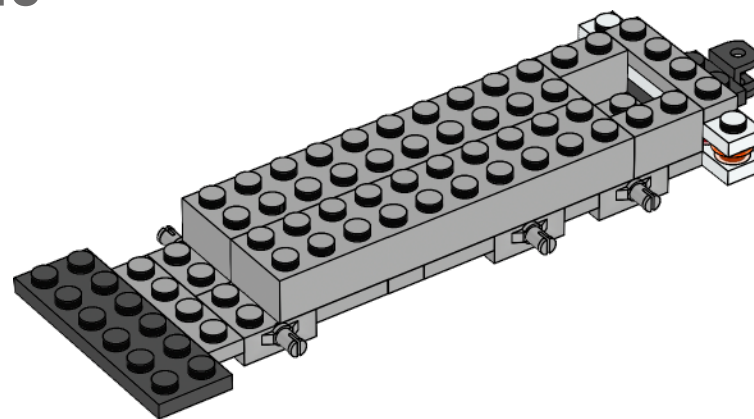

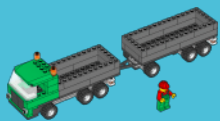

14

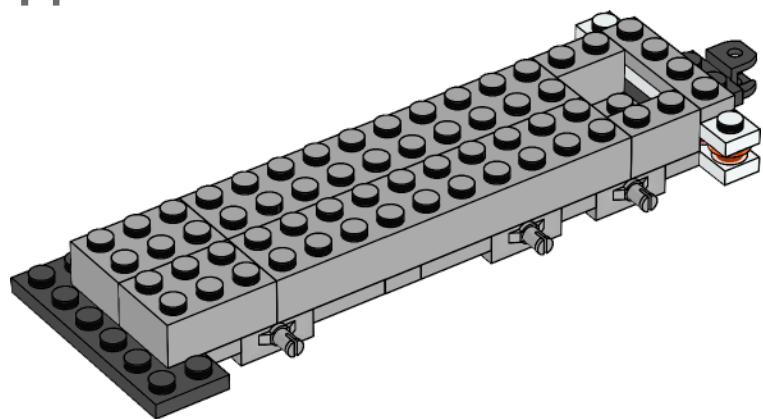

15

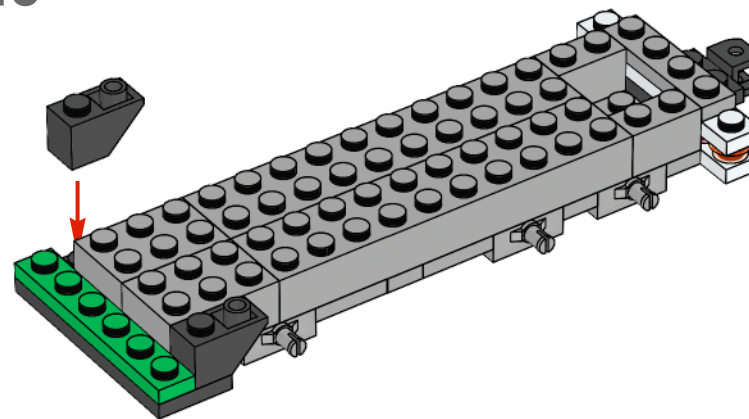

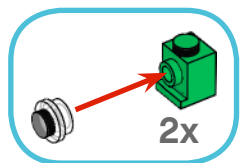
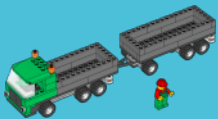

16

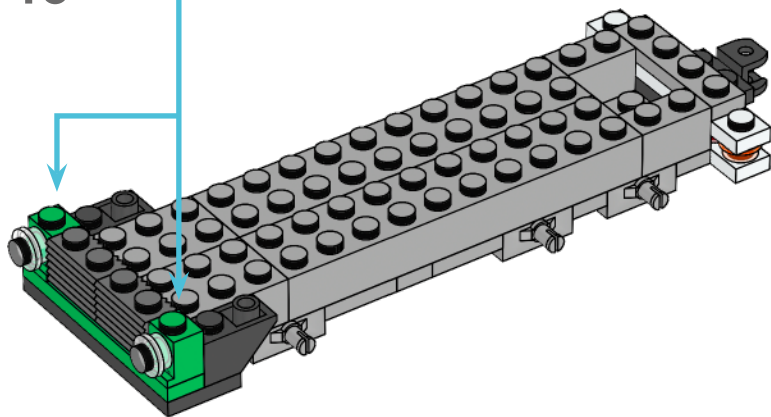

17

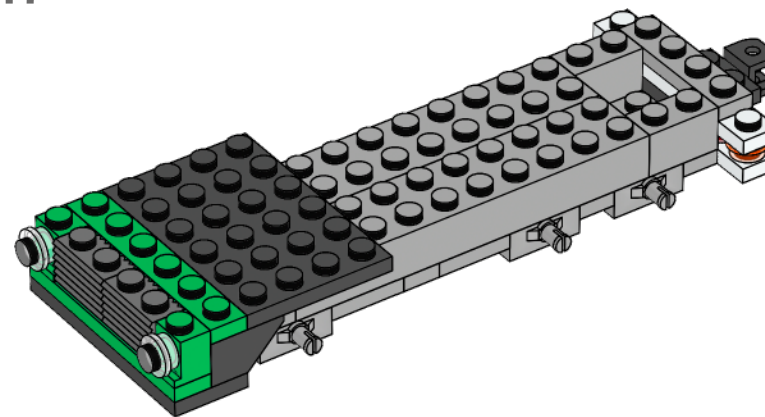

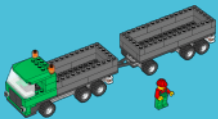

18

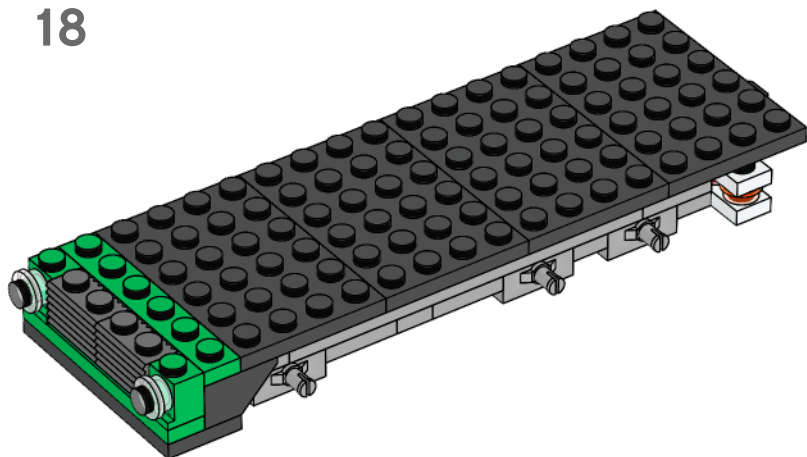

19

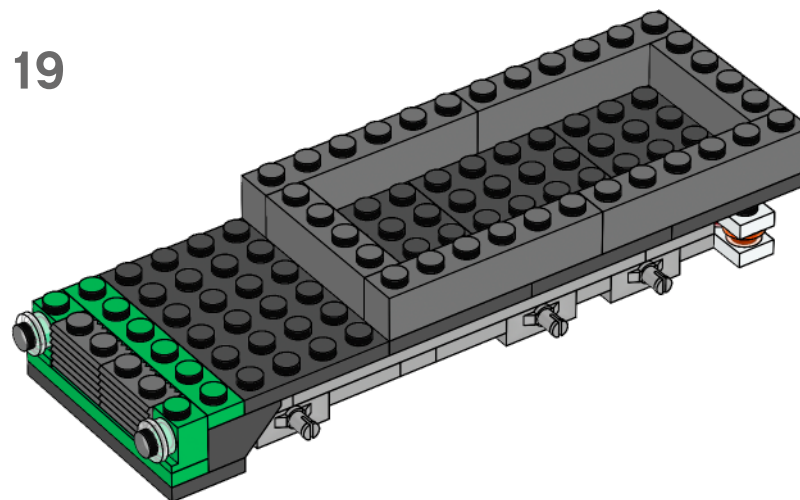

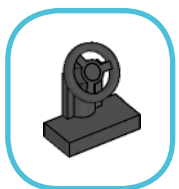
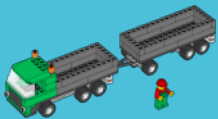

20

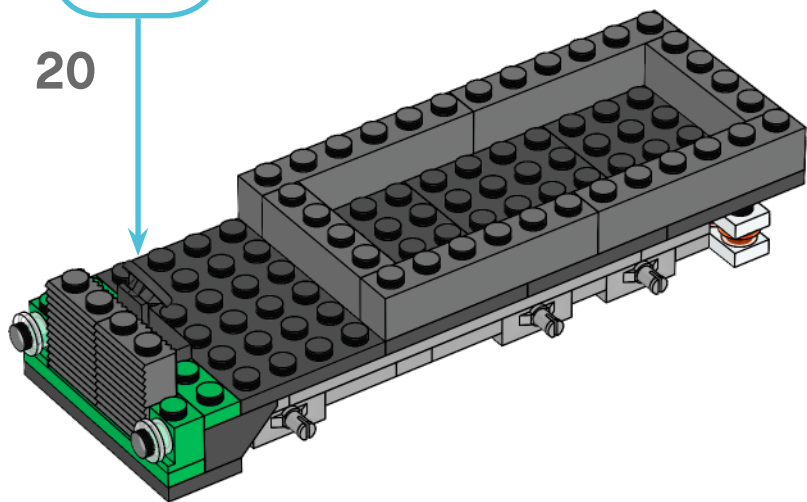

21

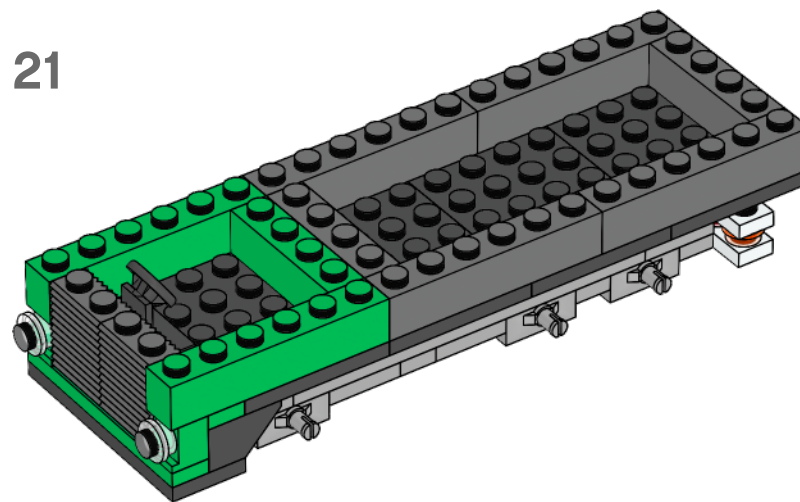

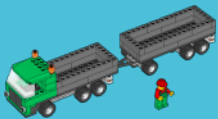

22

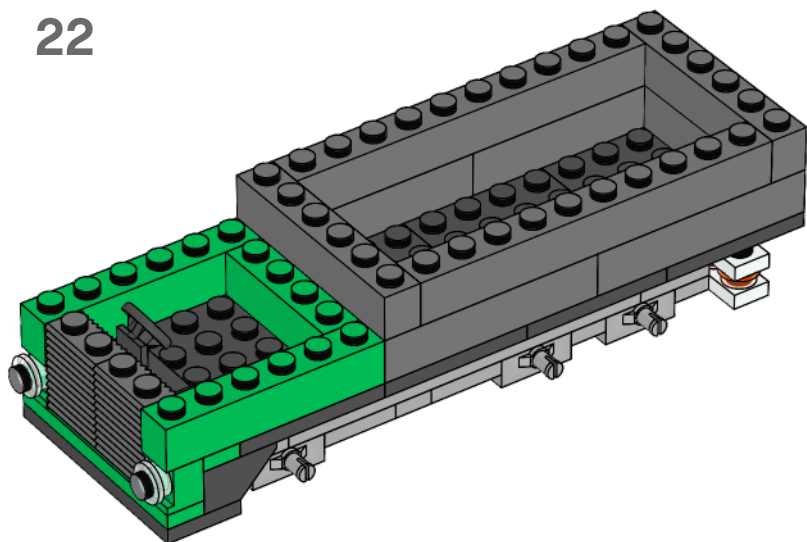

23

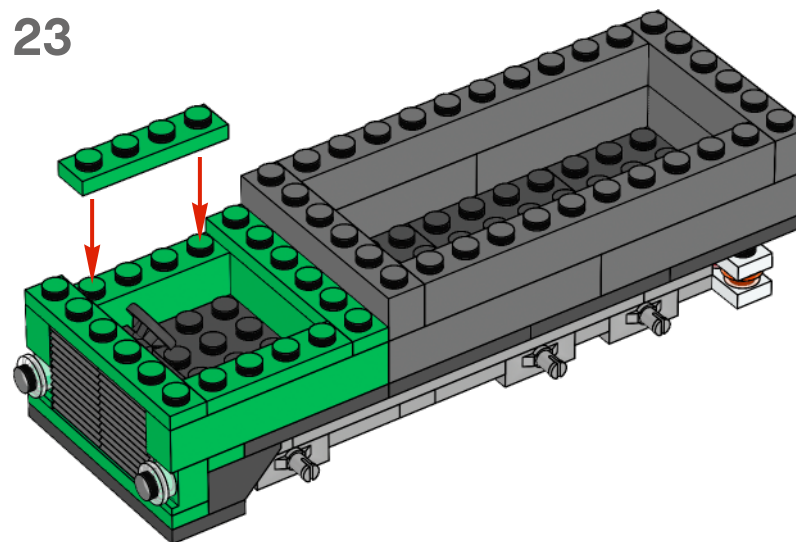

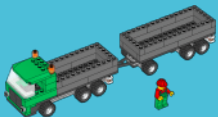

24

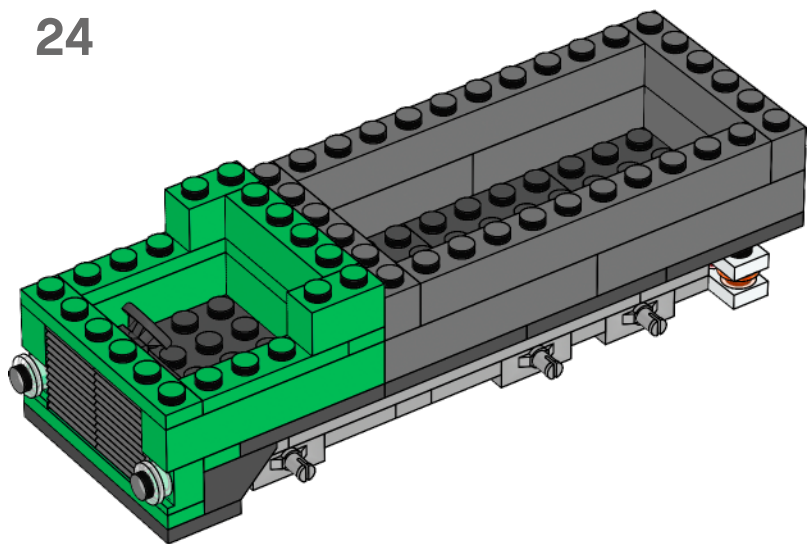

25

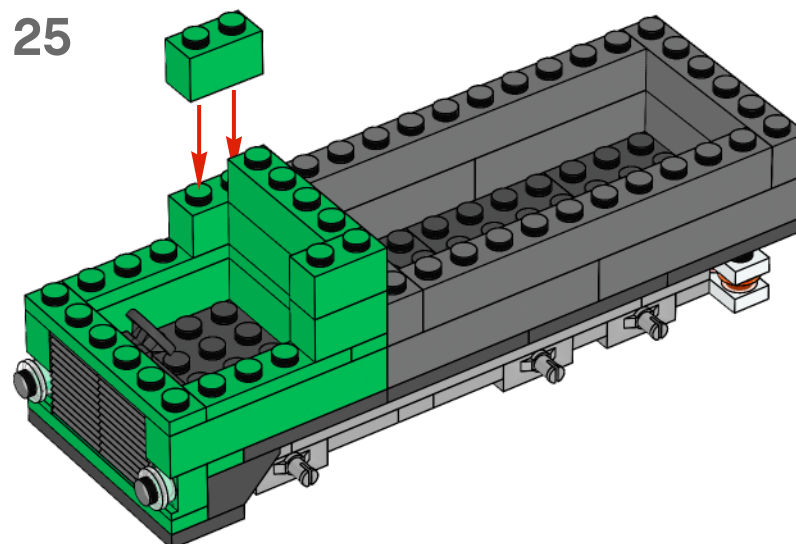

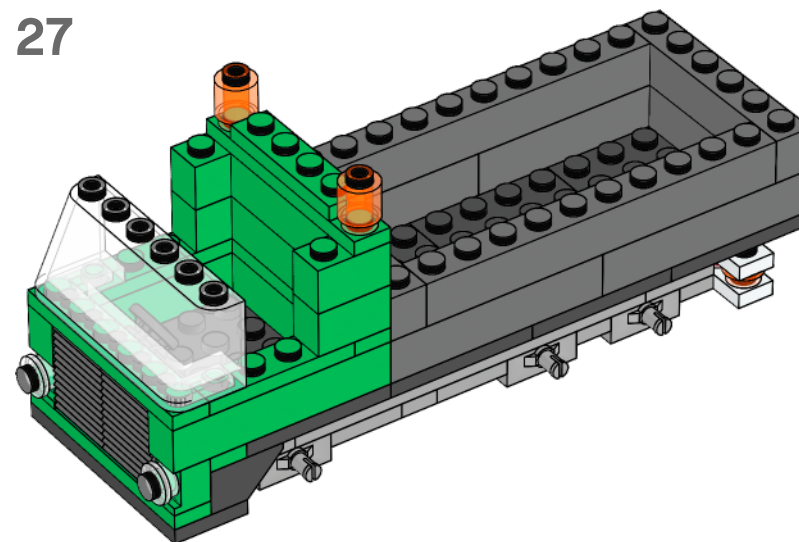
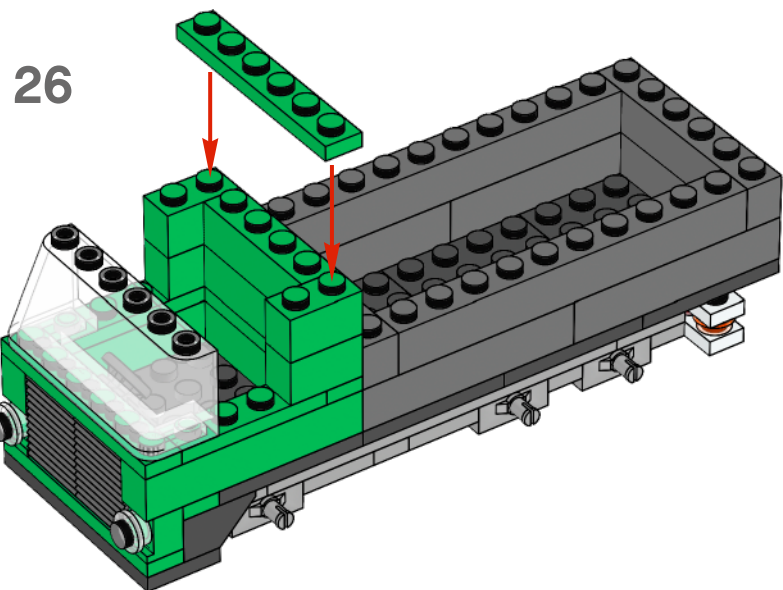
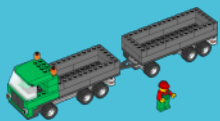

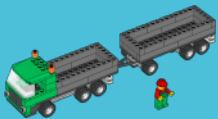

28

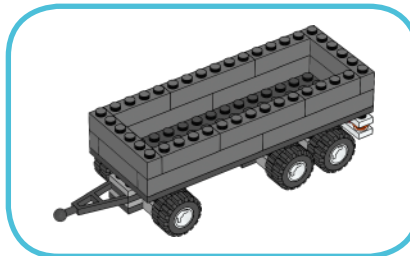
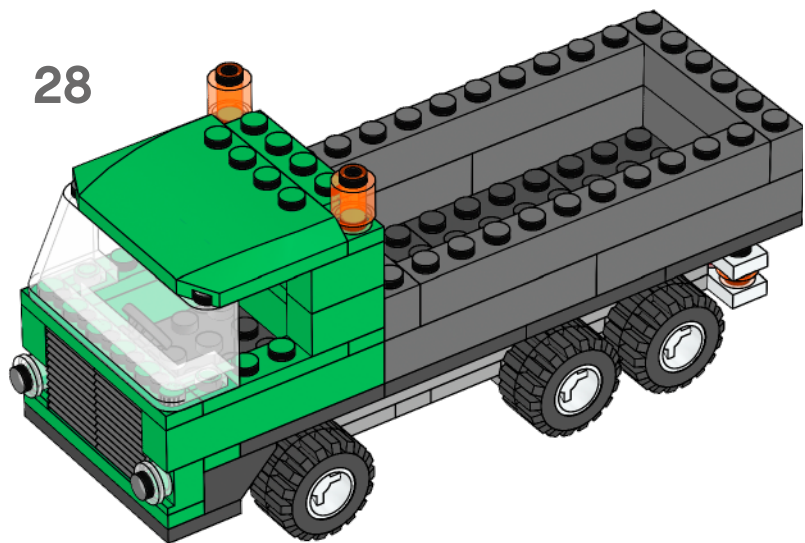

1

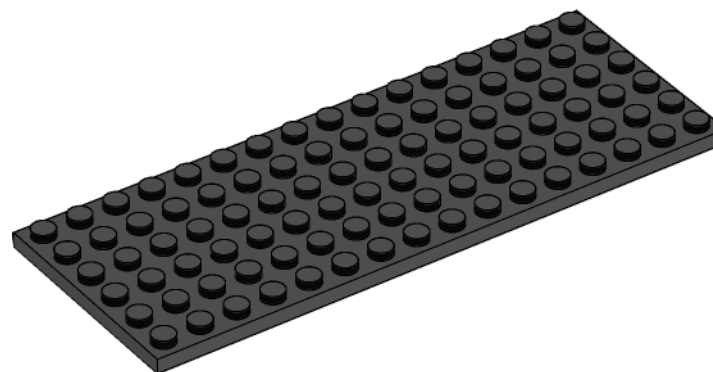

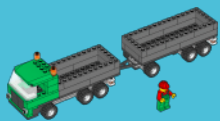

2

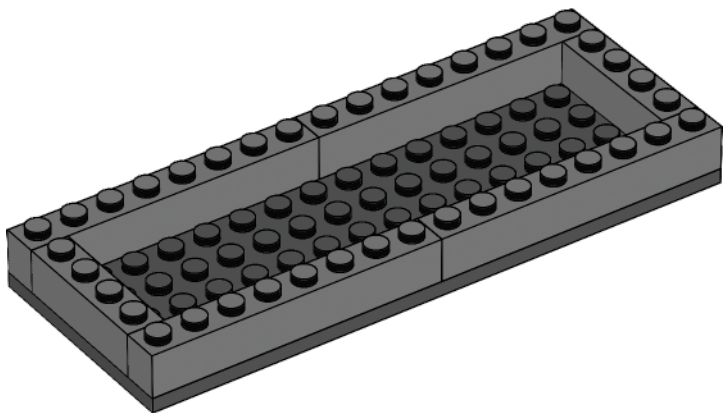

3

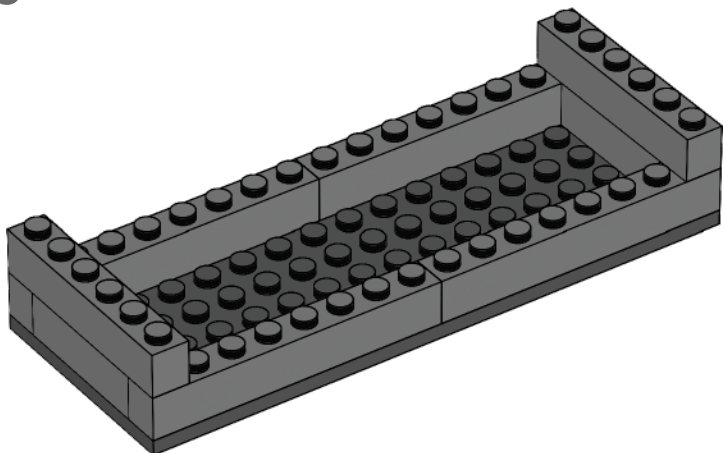

4

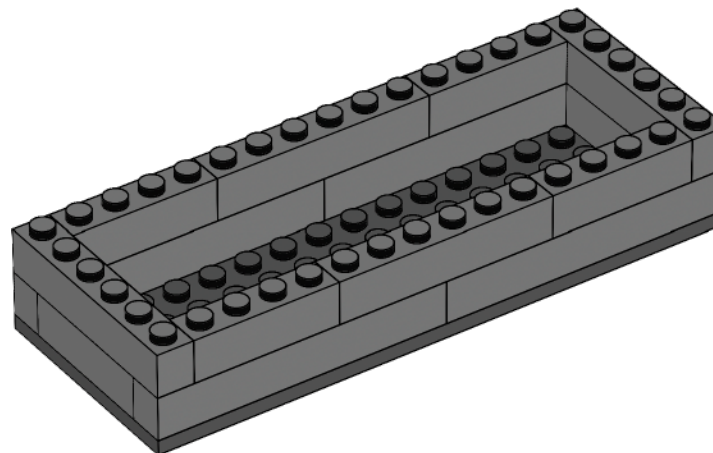

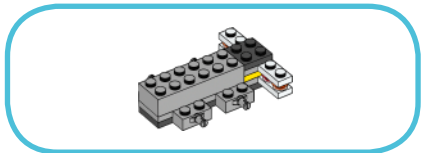
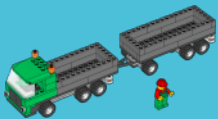

1

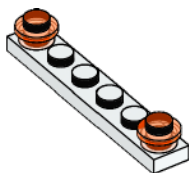

2

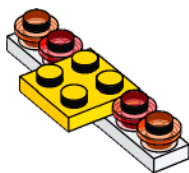

3

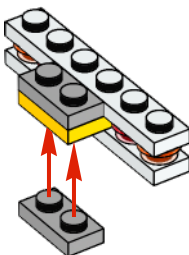

4

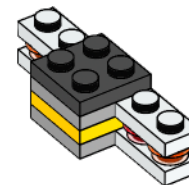

5

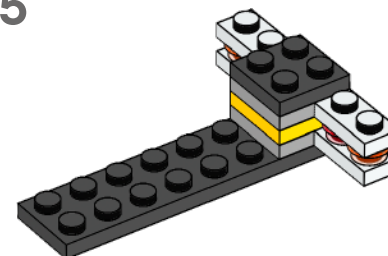

6

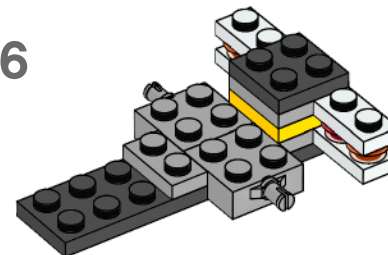

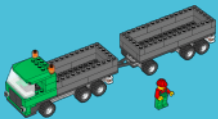

7

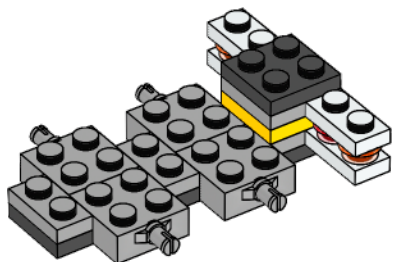

8

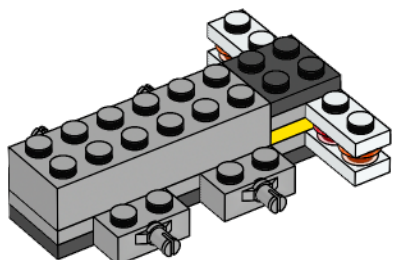

5

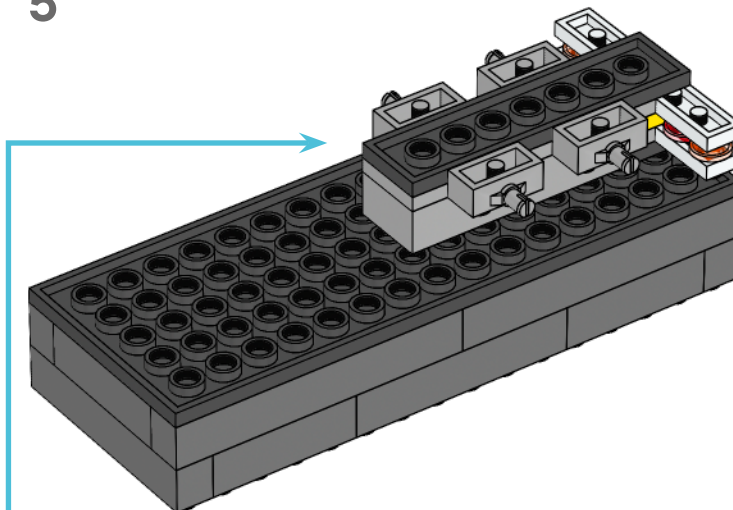

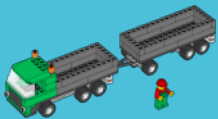

1



2

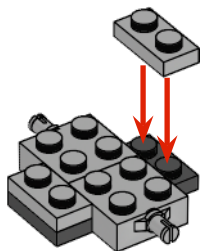

3

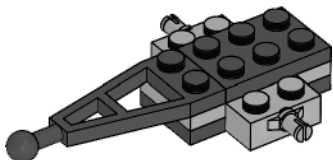

4

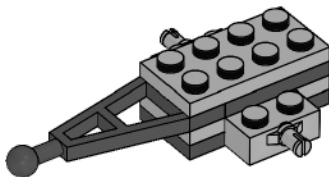

5

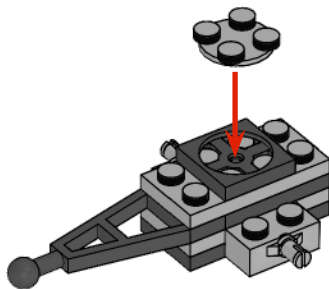

6

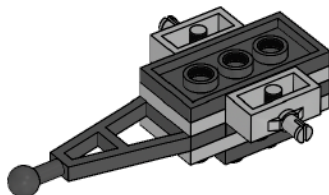

6

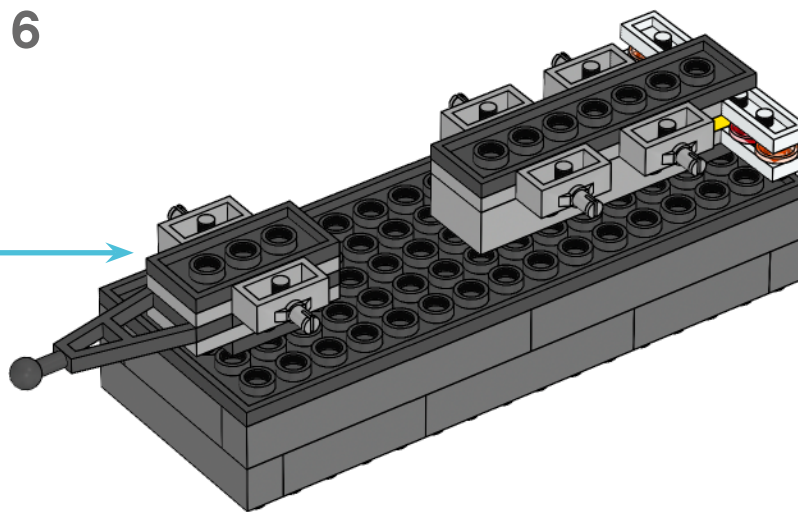

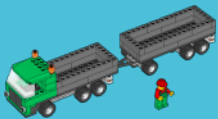

7

